

PHILIPS

Xitanium

LED driver



Datasheet

Xitanium High Bay LED Drivers GL Independent

Xi 240W 0.82-1.35A 1-10V 100-277V RI132S

9290 028 45580

LED-based light sources are an excellent solution for highbay industrial applications.

They are long-lasting and require low maintenance. However, to get the best out of the LEDs, these light sources require highly reliable and efficient LED Drivers. Philips Xitanium Dimmable (1-10V) LED Outdoor Drivers are specifically designed to deliver reliable performance and protection while meeting the strict approbation and application requirements.

Benefits

- Able to reliably operate anywhere around the world
- Reliable and robust design, capable of withstanding the harsh industrial operating conditions
- Wide flexibility by adjusting light output and output current
- Extremely long lifetime, fitting with high bay industrial applications
- Peace of mind. Backed by a 5-year warranty from a company you can trust

Features

- 100-277V (Global) versions
- Independent/IP65 rated
- Adjustable output current
- Dimmable through 1-10V interface
- High ambient temperature rating
- Approbations: CE, ENEC, CB, CCC, UL
- 50,000 hours lifetime

Application

- Highbay industrial lighting
- Warehouse lighting
- Big-box retail store lighting

Electrical input data

Specification item	Value	Unit	Condition
Rated input voltage range	100...277	V _{ac}	Performance range
Rated input voltage	230	V _{ac}	
Rated input frequency range	50...60	Hz	Performance range
Rated input current	1.08	A	@ rated output power @ rated input voltage
Rated input power	250	W	@ rated output power @ rated input voltage
Power factor	0.95		@ rated output power @ rated input voltage
Total harmonic distortion	10	%	@ rated output power @ rated input voltage
Efficiency	96	%	@ rated output power @ rated input voltage @ max. U _{out}
Input voltage AC range	85...305	V _{ac}	Operational range
Input frequency AC range	47.5...63	Hz	Operational range
Standby Power	0.45	W	

Electrical output data

Specification item	Value	Unit	Condition
Regulation method	Constant Current		
Output voltage	160...260	V _{dc}	
Output voltage max.	300	V	Maximum output voltage (rms)
Output current	0.82...1.35	A	
Output current min dimming	82	mA	
Output current tolerance	± 5	%	
Output current ripple LF	≤ 5	%	Ripple = peak / average, < 3kHz
Output current ripple HF	≤ 5	%	
Output P _{st} ^{LM}	≤ 0.13		In entire operating window
Output SVM	≤ 0.07		In entire operating window
Output power	13.6...240	W	

Electrical data controls input

Specification item	Value	Unit	Condition
Control method	1-10V		Output current amplitude dimming, 1-10V acc. IEC60929
Dimming range	10...100	%	1-9V
Isolation controls input to output	Reinforced		acc. IEC61347-1

Wiring and Connections

Specification item	Value	Unit	Type
Input wire cross-section	1.04 / 17	mm ² / AWG	3-wire cable, AWG17, L:Brown, N:Blue, GND:Yellow/Green
Output wire cross-section	1.04 / 17	mm ² / AWG	2-wire cable, AWG17, LED+:Brown, LED-:Blue
Control wire cross-section	0.33 / 22	mm ² / AWG	2-wire cable, AWG22, Dim+:Purple, Dim-:Gray
Maximum cable length	2	m	Total length of wiring including LED module, one way

Insulation

Insulation per IEC61347-1	Mains	Output	Dim & AUX	Ground
Mains		Non	Reinforced	Basic
Output	Non		Reinforced	Basic
Dim & AUX	Reinforced	Reinforced		Basic
Ground	Basic	Basic	Basic	

Dimensions and weight

Specification item	Value	Unit	Tolerance (mm)
Length (A1)	132	mm	
Mounting hole distance (A2)	27	mm	
Width (B1)	113	mm	
Width (B2)	113	mm	
Height (C1)	43	mm	
Height (C2)	66	mm	
Input cable length (E1)	300	mm	
Output cable length (E2)	300	mm	
Control cable length (E3)	300	mm	
Weight	1130	gram	

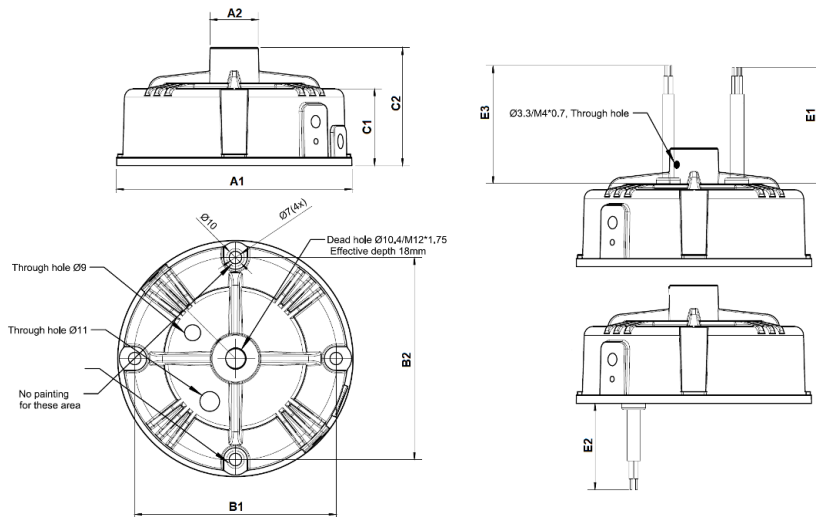

Logistical data

Specification item	Value
Product name	Xi 240W 0.82-1.35A 1-10V 100-277V RI132S
Logistic code 12NC	9290 028 45580
Pieces per box	10

Operational temperatures and humidity

Specification item	Value	Unit	Condition
Ambient temperature*	-40...+60	°C	Higher ambient temperature allowed as long as Tcase-max is not exceeded
Tcase-max	80	°C	Maximum temperature measured at Tcase-point
Tcase-life	70	°C	Measured at Tcase-point Measured at T _c -point
Maximum housing temperature	110	°C	In case of a failure, inherent by design
Relative humidity	10...90	%	Non-condensing

* Note: Ta = 45°C, Tc max = 75°C, Tc life = 65°C @Vin<120Vac;
 Ta = 50°C, Tc max = 75°C, Tc life = 65°C @Vin:120...180Vac;
 Ta = 60°C, Tc max = 80°C, Tc life = 70°C @Vin:180...277Vac

Lifetime

Specification item	Value	Unit	Condition
Driver lifetime	50,000	hours	Measured temperature at Tcase-point is Tcase-max. Maximum failures = 10%

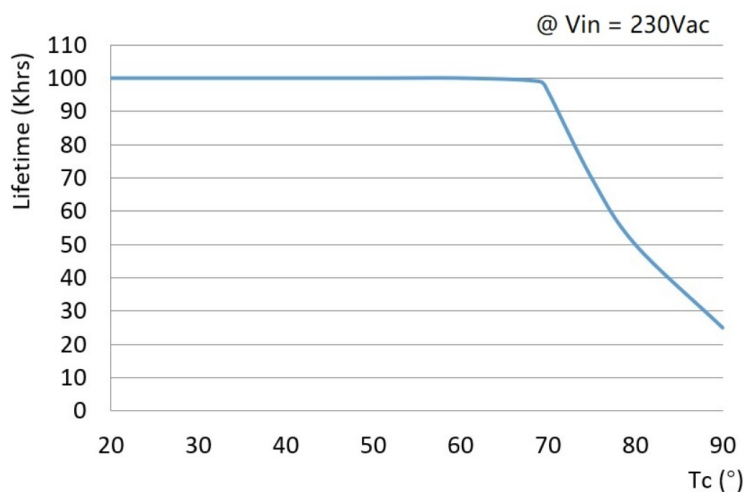

Storage temperature and humidity

Specification item	Value	Unit	Condition
Ambient temperature	-25...+85	°C	
Relative humidity	5...95	%	Non-condensing

Programmable features

Specification item	Available	Default setting	Condition
Set Adjustable Output Current (AOC)	Manual	920 mA	

Features

Specification item	Value	Condition
Open load protection	Yes	Automatic recovering
Short circuit protection	Yes	Automatic recovering
Over power protection	Yes	Automatic recovering
Hot wiring	No	
Suitable for fixtures with protection class	I	per IEC60598
Overtemperature protection	Yes	Automatic recovering

Inrush current

Specification item	Value	Unit	Condition
Inrush current I_{peak}	56	A	Input voltage 230V
Inrush current T_{width}	326	μ s	Input voltage 230V, measured at 50% I_{peak}
Drivers / MCB 16A type B	≤ 5	pcs	Indicative value

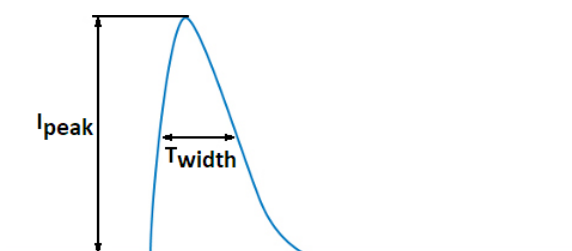

MCB	Rating	Relative number of LED drivers
B	4A	25%
B	6A	40%
B	10A	63%
B	13A	81%
B	16A	100% (stated in datasheet)
B	20A	125%
B	25A	156%
B	32A	200%
B	40A	250%
C	4A	42%
C	6A	63%
C	10A	104%
C	13A	135%
C	16A	170%
C	20A	208%
C	25A	260%
C	32A	340%
C	40A	415%

Driver touch current / protective conductor current

Specification item	Value	Unit	Condition
Typical Protective Conductor Current (ins. Class I)	2	mA rms	Acc. IEC60598-1. LED module contribution not included

Surge immunity

Specification item	Value	Unit	Condition
Mains surge immunity (diff. mode)	6	kV	Acc. IEC61000-4-5. 2 Ohm, 1.2/50us, 8/20us
Mains surge immunity (comm. mode)	6	kV	Acc. IEC61000-4-5. 12 Ohm, 1.2/50us, 8/20us

Application Info

Specification item	Value
Approval marks	CB / CCC / CE / ENEC / RCM / RU
Ingress Protection classification (IP)	65

Graphs

Operating window

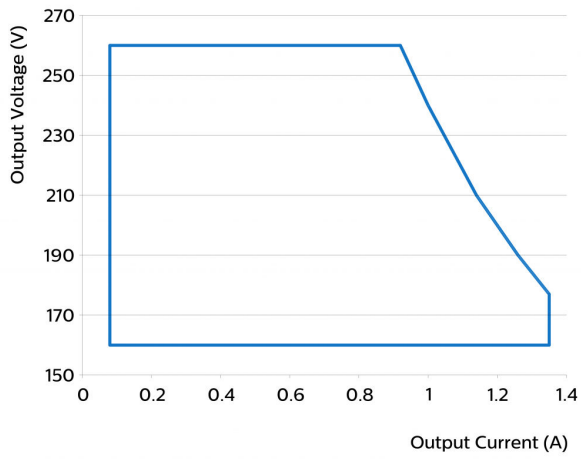

Power factor versus output power

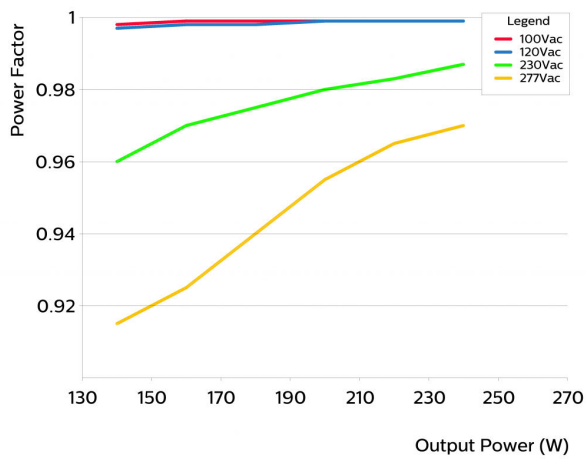

Efficiency versus output power

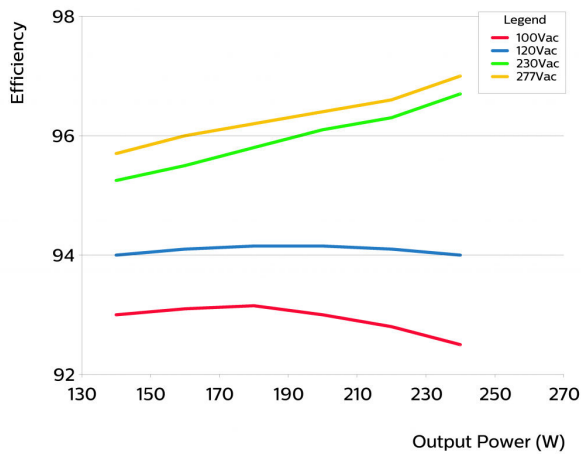

THD versus output power

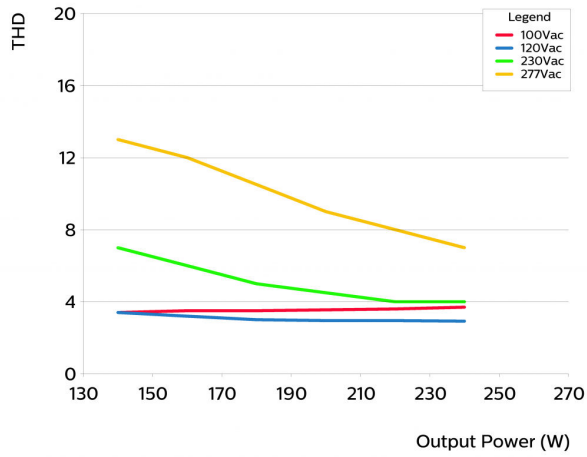

I_{out} as function of 1-10V interface

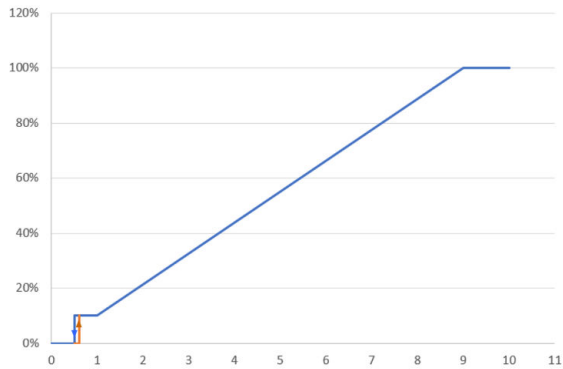

©2021 Signify Holding, IBRS 10461, 5600 VB, NL. All rights reserved.

The information provided herein is subject to change without notice. Signify does not give any representation or warranty as to the accuracy or completeness of the information included herein and shall not be liable for any action in reliance thereon. The information presented in this document is not intended as any commercial offer and does not form part of any quotation or contract, unless otherwise agreed by Signify.

Philips and the Philips Shield Emblem are registered trademarks of Koninklijke Philips N.V. All other trademarks are owned by Signify Holding or their respective owners.

Date of release: August 17, 2021 v2

www.philips.com/oem